

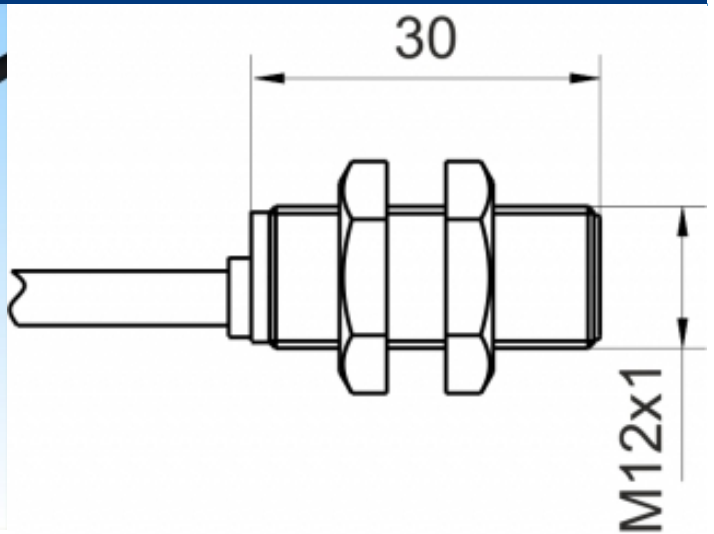

[Article Page](#)

Product Description

inductive sensor NAMUR



Name	KJ2-M12MB30-NA
Order number	08317320300
Matchcode	9932-0300
Switching distance	2 mm
Mounting	 shielded
Signal Type	Namur
Connection	 Cable

Connection diagramm

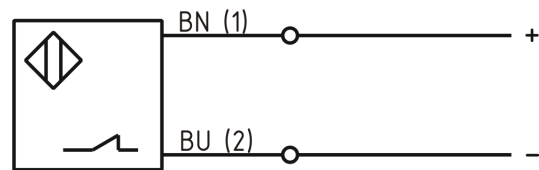

Dimension (in mm)	fine-pitch thread M12 x 30
-------------------	----------------------------

Technical Specification

Operating voltage	6 - 12 V DC
Max. ripple	≤ 5 %
No load current	≤ 3,5 mA
Switching frequency	2000 Hz
Operating temperature	-25 ° C to 60 ° C
Temperature drift	≤ 10 %
Repeat accuracy	≤ 10 %
Time delay	100 ms
Short-circuit proof	yes
Overload protection	yes

Reverse voltage protection	yes
Protection category	IP67
EMC-level	DIN EN 60947-5-6:2000-12
Housing material	Brass, nickel plated
Material active face	PCB
Cable length	2 m
Utilisation category	DC 13
Cable material	PVC LIYY blau (blue)
Nominal operating voltage	8,2 V DC
Cable cross	2x0.25 mm ²
Load Current OFF	ca. 0,5 mA
Load Current ON	ca. 3,5 mA
FIT / MTTF acc. to SIEMENS 29500	16,88 / 6763y

Errors and omissions exceptet