



## ▶ Hybrid stepper motors

**6600-20**

- Step angle ..... 1.8°
- Diameter ..... 57.2 mm
- Weight ..... 570 g
- Holding torque .... 925/680 mNm

The hybrid stepper motor comes into its own where torque at low speed, positioning, and accuracy are determining factors.

### ▶ Technical data

	Part N°	Phase resistance [Ω]	Phase inductance [mH]	Phase current [A]	Holding torque [mNm]	Nominal power [W]
Bipolar	6600-20-2-0.37	0.37	0.9	3.8	925	10.5
	6600-20-2-1.2	1.2	3.7	2.1	925	10.5
	6600-20-2-4.8	4.8	15	1.05	925	10.5
Unipolar	6600-20-4-0.37	0.37	0.45	3.8	680	10.5
	6600-20-4-4.8	4.8	6.5	1.05	680	10.5
	6600-20-4-25	25	33	0.46	680	10.5

Steps/rev.	200
Step accuracy	± 5 %
Rotor inertia	248 gcm <sup>2</sup>
Insulation class	B 130° C
Protection	DIN 40050 IP 30
Test voltage	500 VAC
Detent torque	37 mNm

### ▶ Dimensions

Drawing not to scale. All dimensions in mm.

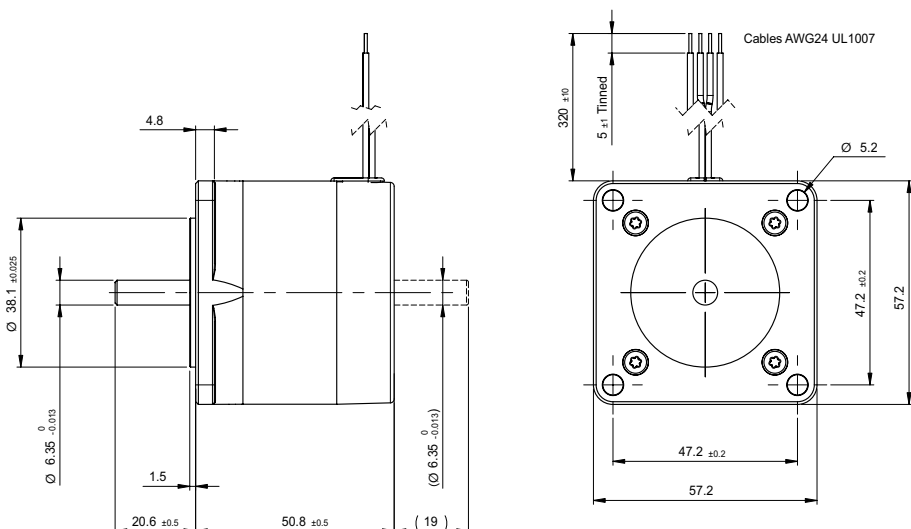

► Dynamic characteristics

• 6600-20-2-0.37

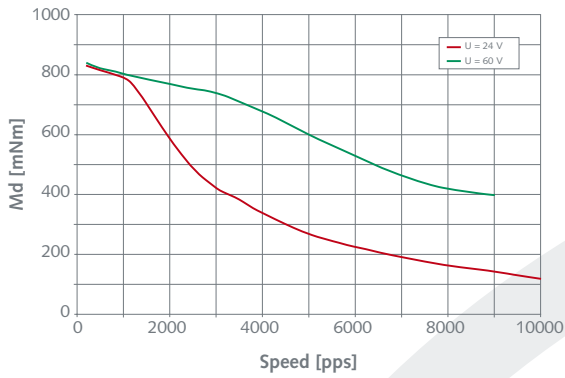

• 6600-20-2-1.2

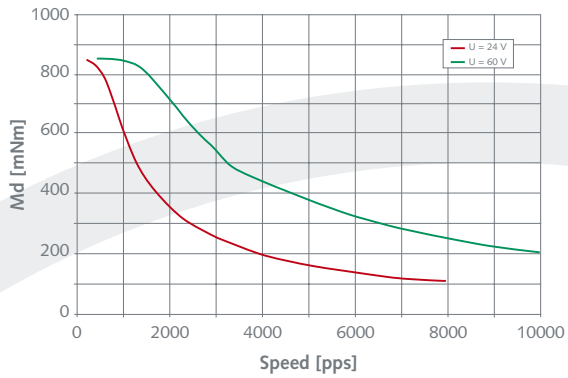

• 6600-20-2-4.8

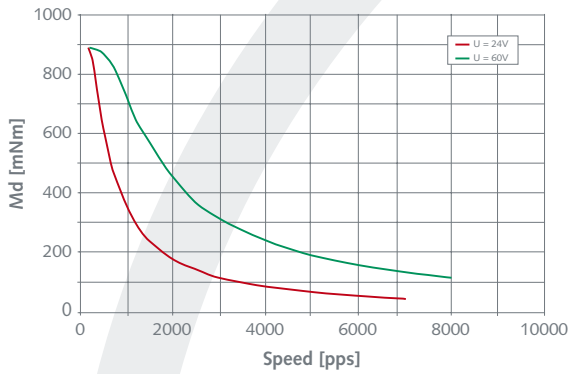

• 6600-20-4-0.37

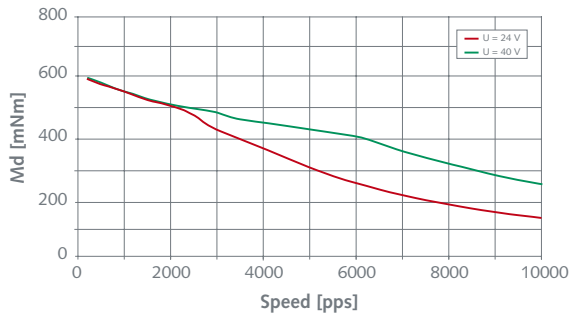

• 6600-20-4-4.8

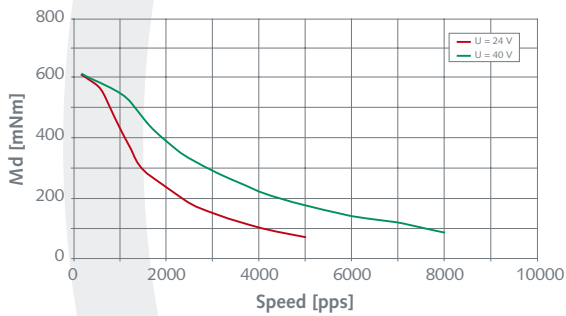

• 6600-20-4-25

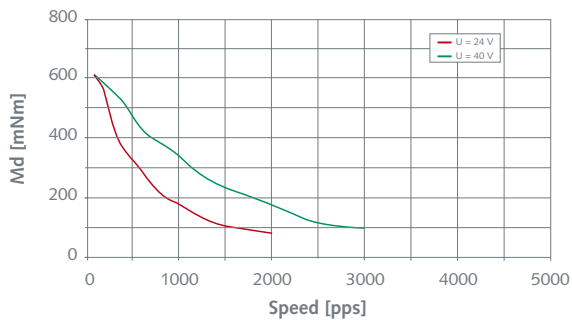

[pps] = pulses per second

Special requirements upon customer specifications. Right to change reserved.

< 1.0 >

▶ Static characteristics

• 6600-20-2 Series

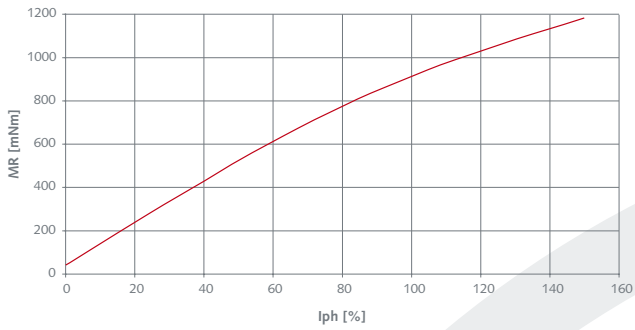

• 6600-20-4 Series

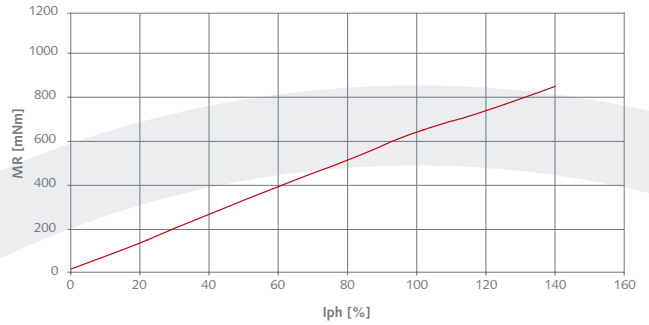

▶ Electrical Interface

• Bipolar

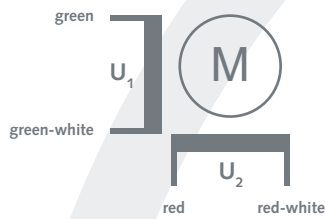

• Unipolar

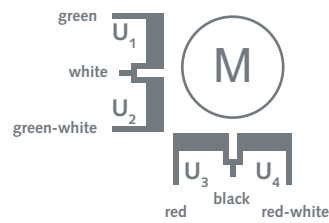

Special requirements upon customer specifications. Right to change reserved.

< 1.0 >

SONCEBOZ SA  
 2605 Sonceboz - Switzerland  
 Tel. +41(0) 32 488 11 11  
 Fax +41(0) 32 488 11 00  
 E-mail : info@sonceboz.com  
 Internet : www.sonceboz.com

