

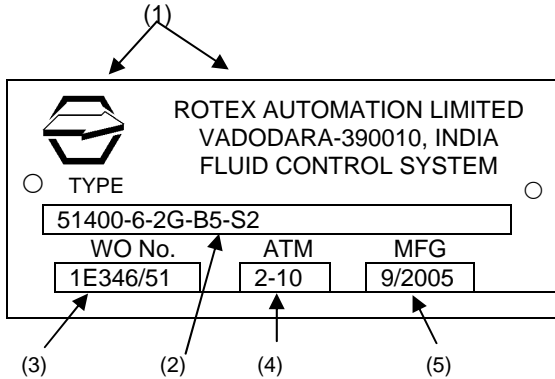

**IDENTIFICATION ON THE SOLENOID VALVE**

**a) VALVE LABEL**

Label on the **ROTEX** Solenoid Valve shows the following details :



- (1) Logo + Manufacturer's Name & address
- (2) Valve Type / Code
  - 51400 = Valve Model
  - Suffix = Nil
  - 6 = Orifice
  - 2G/3G = 1/4" / 3/8" Port Connection (BSP)
  - B5 = Body Material (SS316)
  - S2 = Seal Material (Viton)
  - = Manual Override (Push & Turn)
  - 110V = Solenoid Voltage
  - 50Hz = Current (AC)
  - 22 = Solenoid Construction (Enclosure : Plug In)
  - H = Solenoid Class 'H' Insulation
  - Sp. Version = Nil
- (3) Manufacturer's Work Order reference / Sr. No. of the Valve
- (4) Operating Pressure
- (5) Manufacturing Month & Year
- (6) Valve Symbol
- (7) Media
- (8) ATEX Ex mark for Valve (Non Electrical Part)
- (9) "CE" mark for ATEX and/or PED compliance.

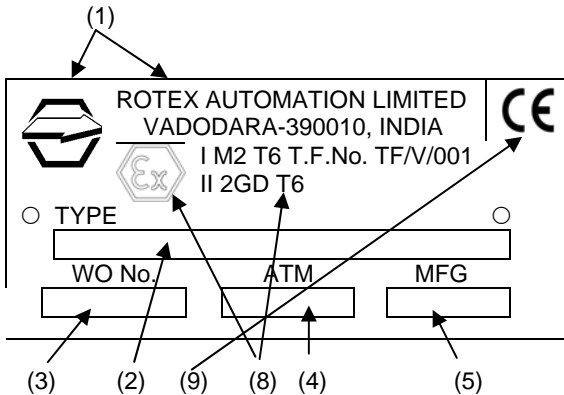
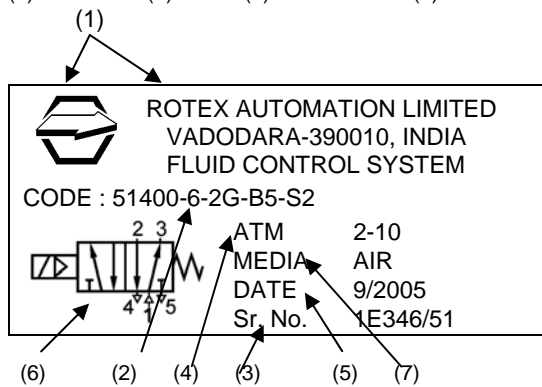

**b) SOLENOID LABEL**

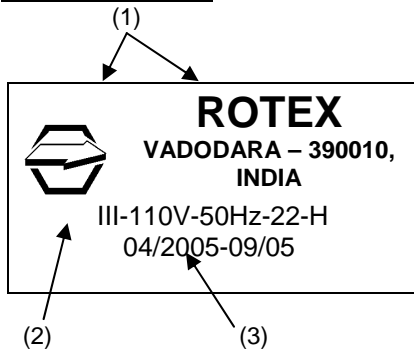

- (1) Logo + Name of the Manufacturer
- (2) Solenoid Type
  - III = Solenoid Size III
  - 110V = Solenoid Voltage
  - 50 Hz = Solenoid Current
  - 22 = Solenoid Construction (Plug In DIN)
  - H = Solenoid Class H Insulation
- (3) Plan No. & Manufacturing Month / Year

**c) PORT IDENTIFICATION**

A solenoid Valve with NPT (F) threading is normally marked “N” near the port and with Metric threads are marked “M”. For ports with BSP threads, there is no marking.

d) Voltage, current & other details are additionally marked/punched on the solenoid.

**⚠ NOTE : The product without label is out of warranty and risk.**

**CONNECTION**

VALVE TYPE	Inlet	Outlet	Outlet	Exhaust	Exhaust	Pilot Vent	External Pilot Inlet
51400,51401,51402,51403 Internal Pilot Operated	1	2	3	4	5	6	-
52400,52401,52402,52403 External Pilot Operated	1	2	3	4	5	6	7

**A) OPERATING PRINCIPLE**

When the solenoids is de-energised and pressure applied at the inlet port, a part of media from the inlet is drawn through the pilot passage which is blocked under Plunger (Part-30). In case of External Pilot Operated Valve the pilot passage is blocked by Gasket (Part-00) and pilot air connected to Port-7 of the valve is blocked under Plunger (Part-30). Port-2 to 4 and Port 1 to 3 are connected, Port-5 is blocked.

On energisation of the solenoid, Plunger (Part-30) moves up thereby blocking pilot vent orifice. The air from pilot passage acts on the piston assembly thus, pushing the poppet assembly down and connecting to Port-1 to Port-2 and Port-3 to Port-5 and blocking Port-4.

On de-energising the solenoid, the pilot air is vented through pilot vent thereby the spring and media air pressure pushing the poppet assembly up.

**NOTE : IN CASE WHEN THE VALVE IS OPERATED AS EXTERNAL PILOT OPERATED VALVE, THE PILOT AIR PRESSURE SHOULD BE MINIMUM 2 bar OR ≥ MAIN FLUID PRESSURE WHICHEVER IS MORE.**

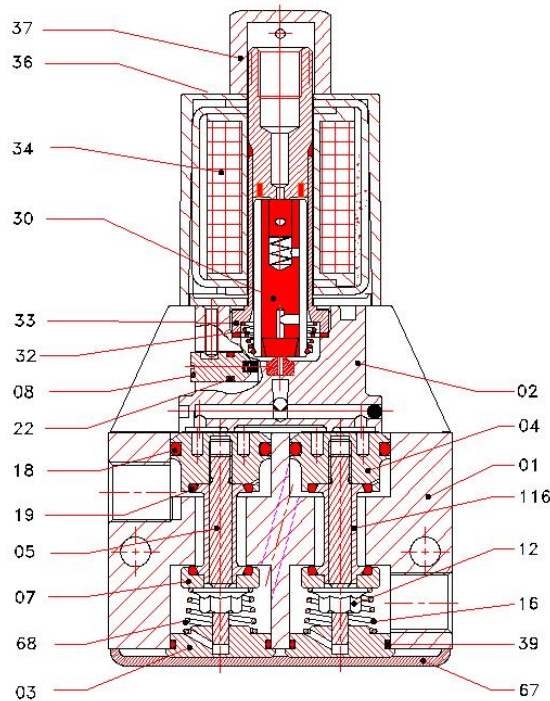

02	DISTANHULSE (HULSE)	22	116	BRASS/SS
01	VENTIL FEDER (VALVE SPRING)	21	68	SS302 (HARD)
01	BOTTOM PLATE	20	67	MS
02	BODY 'O' RING	19	39	NBR/VITON/EPDM
01	DOME NUT	18	37	PLASTIC
01	DATA PLATE	17	36	AL
01	COIL ASSLY.	16	34	-
01	GUIDE ASSLY.	15	33	SS304+SS430
01	GUIDE 'O' RING	14	32	NBR/VITON/EPDM
01	PLUNGER ASSLY.	13	30	SS430
01	M.A. 'O' RING	12	22	NBR/VITON/EPDM
04	SEAT 'O' RING	11	19	NBR/VITON/EPDM
02	KOLBEN (PISTON) 'O' RING	10	18	NBR/VITON/EPDM
01	VENTILFEDER (VALVE SPRING)	09	16	SS302 (SOFT)
02	NUT	08	12	MS
01	PUSH & TURN M.A.	07	08	BRASS/SS
02	VENTILTELLER (PRESSURE PLATE)	06	07	BRASS/SS
02	VENTILSHAFT (VALVE SHAFT)	05	05	BRASS/SS
02	KOLBEN (PISTON)	04	04	BRASS/SS
02	VENTILBODEN (VALVE BOTTOM)	03	03	BRASS/SS
01	DECKEL (COVER)	02	02	AL/BRASS/SS
01	GEHAUSE (BODY)	01	01	AL/BRASS/SS
QTY.	DESCRIPTION	SR.No.	POS.No.	MATERIAL

**(B) MOUNTING/INSTALLATION PROCEDURE :**

1. ENSURE THAT :

- a) While storing, keep the valve in cool, dry, dust free area.
  - b) On receipt of the valve, in case if the same is to be removed from the sealed plastic bag for inspection/testing, put them back with dust plugs on its ports and sealing the plastic bag as soon as the inspection/testing is over.
  - c) The valve should be removed from its card board and/or plastic bag just before the installation.
  - d) Flush lines before installing the valve.
  - e) To avoid pressure drop and to achieve optimum parameters, Pipe / Tube / Fitting from the source of pressure to the valve and to the connected equipment should have ID which is  $\geq$  NW (Orifice) of the valve.
  - f) To avoid pressure drop, if more than one valve is being operated simultaneously from a common header, then minimum ID of the header can be calculated as under.  

$$ID \text{ Header} = \sqrt{NW^2 \times n}$$
 n = Number of Valves operating at a time and which are connected to a common header,  
 NW = Orifice of the Valve.
  - g) Incorporate filter in the line to avoid hard particles entering into the valve.
  - h) The valve should be installed for the media for which it is intended for. This is to avoid the malfunction of seals and the valve. In case if you intend to use valve for media other than the one specified on that valve, check compatibility of media to Body Seal material and grease. Consult **ROTEX** in case if any doubt.
  - i) Do not try to drill any additional holes or machine, modify any of the valve components.
  - j) In case if the valve is used for dangerous fluid gas/liquid then, the user is hereby advised to maintain during operation and maintenance of the valve below LEL or above UEL to avoid explosion due to internal spark as the valves have not been assessed for the same.
  - k) Inlet pressure does not exceed rated pressure.
  - l) Hemp-Filaments, 'Jute' or even Teflon-Ribbons are normally not required, as the port connections of ROTEX Valve is accurately machined.
  - m) To avoid over lap of the Teflon ribbon or cuts generated while tightening, getting carried away into the valve. Do not cover first two thread pitches with Teflon tape or sealant.
  - n) **For Solenoid Valve to be installed in European Union, check the applicability for ATEX, PED Directives. Refers separate Instruction Manual for ATEX approved Solenoid Valve.**
  - o) **To Avoid Malfunction of Valve**  
 Do not block exhaust port (by installing Flow Control Valve, Needle Valve etc.) for speed regulation of the equipment connecting to the outlet port of the valve. It is recommended to connect speed regulation device like Fluid Control Valve / Needle Valve etc. between the outlet port of valve and equipment.
2. Provide Dust Cap on the exhaust port or ensure that the valve is mounted such a way that dust particles / rain water / process fluid do not enter into the valve through exhaust port of the valve. You can connect bend pipe of ID  $\geq$  NW of the valve so that the exhaust port is not directly (straight) open into the atmosphere.
3. The process fluid etc. do not fall on the valve body.
4. Install valve in such a way that the rain water / other process fluid dripping along the cable does not fall on the SOV and has no possibility to run along the cable and enter into the Terminal area.
5. In case if the valve is installed in potentially Hazardous area, check for the temperature class of the Solenoid to avoid explosion due to heated Solenoid / other components.
6. Provide fuse of proper rating to avoid excess current passing through the Solenoid and thereby avoiding over heating.
7. It is not likely however, the user is advised to protect the valve against lightening as the same is not assessed.
8. Check internal components (wetted) parts for its compatibility with fluid passing through the valve.
9. **It is recommended to replace all the Rubber Parts including Plunger Assembly (Repair Kit – Code 99) in case if the valve is to be installed and put in service after 2 years from the date of manufacture.**

**10. APPLICABILITY OF PED**



For applicability of PED for the Solenoid Valve to be installed in European Union, refer chart given hereunder :

Orifice in mm	Pressure Rating in Kg/cm <sup>2</sup>			
	Non-Hazardous Gas Orifice $\geq$ 32 PS DN $\geq$ 1000	Hazardous Gas Orifice $\geq$ 25 PS DN $\geq$ 1000	Non-Hazardous Liquid Orifice $\geq$ 10 PS DN $\geq$ 5000	Hazardous Liquid Orifice $\geq$ 0.5 PS DN $\geq$ 2000
25 mm	-	$\geq$ 40	$\geq$ 200	$\geq$ 80
40 mm	$\geq$ 25	$\geq$ 25	$\geq$ 125	$\geq$ 50
50 mm	$\geq$ 20	$\geq$ 20	$\geq$ 100	$\geq$ 40
65 mm	$\geq$ 15.38	$\geq$ 15.38	$\geq$ 76.92	$\geq$ 30.76

REMARKS

- 1) Solenoid Valve in which media passing through the valve is **Gaseous** and Orifice less than 25mm, PED is not applicable.
- 2) Solenoid Valve in which media passing through the valve is **Liquid Hazardous** nature, pressure 0.5 bar and **Liquid Non-Hazardous** nature, pressure below 10 bar, PEF is not applicable.

ELECTRICAL

1. Verify name plate affixed on the Solenoid.
2. Connect the power supply according to the voltage rating of the Solenoid
3. Ensure that the cover of Junction Box/Terminal Box is properly tightened wherever applicable.
4. Install valve in such a way that the rain water / other process fluid dripping along the cable does not fall on the SOV and has no possibility to run along the cable and enter into the Terminal area.
5. Fill in the space between cable and gland entry with a proper sealant. If necessary, you may mount the valve upside down or in any other direction.
6. Ensure that the Solenoid enclosure meets process and local authority requirement.
7. The Plug In, Terminal Box, FPJB, IS Solenoids are provided with test leads. Remove them before final installation.
-  8. Check for proper connections for the Solenoid which are polarity sensitive e.g. (a) Latched Solenoid (b) EEx ia Solenoid.
-  9. **Refer separate manual for construction of the Solenoid and for specific instructions related to Solenoid e.g. (a) EEx ia (b) Latched Solenoid (c) EExd Solenoid IP 67, IP 54**
10. Ensure that the solenoid construction is selected properly meeting the environment in which the valve is supposed to be installed e.g. use of Exd or Ex ia solenoid for valve to be installed in hazardous location or Weatherproof Solenoid having IP 67 for outdoor installation.
-  11. Flying Lead Solenoid is not recommended to be used for outdoor or indoor application where water/liquid splashing or high humidity is present.

MANUAL OVERRIDE OPERATION(A) **PUSH & TURN TYPE (M6)**

When the solenoid is deenergised (Photo-4) and inlet and outlet ports connected, applying rated pressure, the valve can be operated either pressing the Manual Override, when the same is released, the valve returns back to the normal position. The valve can also be locked in energized (Photo-3) position by pushing the Manual Override and rotating clockwise. To avoid Manual Override returning back to normal condition, ensure that the same is turned above 90°. The valve can be brought to normal condition by turning Manual Override anti clockwise.

(B) **PUSH TYPE (M8)**

When the solenoid is deenergised, inlet and outlet ports connection and rated pressure applied, the valve can be brought to energized position by pressing Manual Override / Lever. The valve remains in this position till Manual Override / Lever is pressed. As soon as the same is released, the valve returns back to the normal position.

Without connecting air supply to the valve operate Manual Override. Energise and De-energise Solenoid to check for plunger movement (normally movement should not be there) which can be felt by click sound.

After operating Manual Override if plunger movement is found, reduce length by 0.3mm of the manual override from its taper end. Continue this till click sound stops.

(C) **CHANGE ORIENTATION OF MANUAL OVERRIDE POSITION**

- 1) Remove solenoid by opening Dome Nut (Part-37).
- 2) Remove Nylon Cover.
- 3) Open 4 Nos. screw.
- 4) Change the Gasket ensuring that the hole in Gasket matches to the dia 3 mm hole in the body (away from the ports i.e. the dia 3 mm hole not opening into Port-7 of the Valve).
- 5) Refix cover by rotating 180°.
- 6) Pier hole (remove knock out) in plastic cover (hole on opposite face)
- 7) Fix Nylon Cover on the Cover.
- 8) Fix Solenoid.

**TO CONVERT INTERNAL PILOT OPERATED VALVE TO EXTERNAL PILOT AIR OPERATED VALVE**

- 1) Remove solenoid by opening Dome Nut (Part-37)
- 2) Remove Nylon Cover.
- 3) Open Deckel (Cover) (Part- 2) by opening 4 Nos. Screw.
- 4) Turn Gasket 180° ensuring that the pilot hole in rubber gasket matches to the pilot hole drilled in the body which is opening to Port-7 (1/8" BSP) of the valve.
- 5) Refix cover ensuring that the manual override is at desired position.
- 6) Fix Nylon Cover.

- 7) Fix Solenoid
- 8) The valve will operate with no pressure at Port-1. However, an External Pilot of min. 2 bar or  $\geq$  main fluid pressure whichever is more is to be connected to Port-7 of the valve.
- 9) The Photo-8 illustrate external pilot air operated valve having different manual override.  
 For such an application, valve type 52400/52401/52402/52403 is to be selected.

**TESTING OF THE VALVE AT THE TEST BENCH**

-  Check at least once in 3 years or following your routine maintenance schedule.
- a) Apply rated pressure at inlet port of the valve.
  - b) Plug outlet ports.
  - c) Check operation of the valve and leakage at the exhaust ports and pilot vent at the rated and minimum working pressure by applying 75% to 120% rated voltage.
  - d) While keeping the solenoid de-energised, check operation and leakage from exhaust and pilot vent ports of the valve at the rated and minimum working pressure by operating Manual Override.

-  Check at least once in 3 years or following your routine maintenance schedule.
- a) Apply rated pressure at inlet port of the valve.
  - b) Plug outlet ports.
  - c) Check operation of the valve and leakage at the exhaust ports and pilot vent at the rated and minimum working pressure by applying 75% to 120% rated voltage.
  - e) While keeping the solenoid de-energised, check operation and leakage from exhaust and pilot vent ports of the valve at the rated and minimum working pressure by operating Manual Override.

-  f) Without connecting air supply to the valve, operate Manual Override. Energise and De-energise Solenoid to check for the plunger movement (normally movement should not be there) which can be checked by click sound. After operating Manual Override if plunger movement is found, reduce length of the manual override by 0.3mm from its taper end. Continue this till click sound stops.
- g) Check the insulation resistance of the Solenoid by applying 500V DC at terminals and the solenoid housing. It should be more than 100 Mega Ohms.

**RECOMMENDED SPARES**

- a) Seal Kit (O Ring) (Code – 98).
- b) Plunger assembly (Part No. 30).
- c) Spare Solenoid. (Code – 34)
- d) Repair Kit (Code – 99)

**SPARE ORDERING CODE**

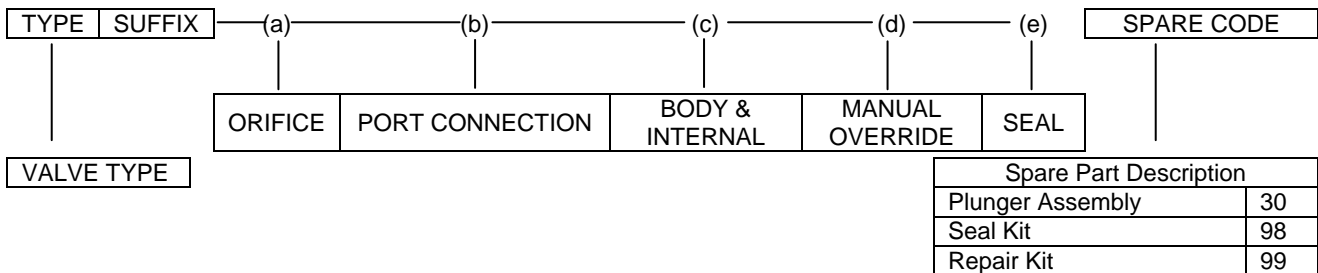

**SPECIAL TOOLS**

- Guide Opening Tool : **ROTEX** Ref No. WN 1219 / M28 (Photo-1) or WN1219 / M22 (Photo-2) (ROTEX make).
- Kolben Opening Tool.



**RECOMMENDED MAINTENANCE**

- Replacement of Complete Set of O Ring ... ..  
 - Solenoid O Ring (Part 35), Guide O Ring (Part 32),  
 - MA O Ring (Part 22), Body O Ring (Part 20),  
 - Seat O Ring (Part 19), Piston O Ring (Part 18)
- Replacement of Plunger Assembly ... ..
- Replacement of the Solenoid ... ..
- Check of Insulation Resistance, Resistance of the Solenoid...
- Check Resistance of the Solenoid... ..  
 (Not applicable for Solenoid with IS, RC options or AC Solenoid with  $\geq$  11 Watt power).

**PREVENTIVE**

- Once in 5 years or 2 million operations.
- Once in 5 years or 2 million operations
- As and when required.
- Once in a year (shouldbe  $\geq$  100 MOhms @ 500V DC.
- Replace Solenoid if the resistance reduces more than 5% computed at 20°C as compared to its Initial value.

**MAINTENANCE – GENERAL INSTRUCTION**

- The Solenoid Valve must be removed from the site and has to be maintained under safe conditions.
-  • All air and electrical connections must be switched off before removing valve from the line.
-  • It is recommended to replace complete set of O Ring even if one of the O Ring is damaged. This is to ensure trouble free operation of the valve and will avoid its premature failure.
- Using Grease other than Silicon base Molykote M55 will lead to premature failure of O Rings of the **ROTEX** Solenoid valve.
-  • If necessary to clean the components, **do not use Kerosene, Diesel, Petrol to clean valve as this damages the O Rings and other rubber material. Instead use light Detergent Soap Solution.**
- Ensure that the components are free from dust, dirt, lint and metal burrs.
- Twisting of O Ring should be avoided. Ensure that the twist is removed before fitting matching part.
- While closing the matching part, the matching part should be pushed in a straight line. Turning motion should be avoided.
- Pinching of O Ring at the groove corner at the time of closing gland should be avoided.
- User is requested to use safe practice for maintenance.
- It is important to place the dismantled Valve Parts on a clean paper or cloth in same sequence in which you have dismantled them.
- Ensure to keep all the components of the valve separately to avoid their mixing up. The component appears to be same may have small differences which will cause malfunction if interchanged.
- In case of difficulty you should contact the Agent, Distributor or **ROTEX** directly.
- Using **ROTEX** genuine spares will **Guarantee** you trouble free operation and will avoid premature failure.

**(A) TO REPLACE SOLENOID**

- 1) Open dome nut (Part 37) and pull out solenoid (Part 34)
- 2) Replace new solenoid ensuring the construction, voltage and current meets the requirements.
- 3) Tighten the dome nut (Part 37) applying torque of 0.2 kgm to 0.35 kgm to avoid over tightening of the solenoid.
- 4) Measure and record resistance of the Solenoid.

**(B) TO REPLACE GUIDE ASSEMBLY (CORE TUBE) (Part 33) / PLUNGER (Part 30)**

- 1) Open dome nut (Part 37) and pull out solenoid (Part 34).
- 2) Open Guide Assembly (Core Tube) (Part 33) using guide opening tool as per Photo - 2 or 3 (depending on the Guide Assembly (Core Tube) fitted on the valve).
- 3) Remove Plunger Assembly (Part 30).
- 4) Replace the necessary defective parts ensuring that the plunger assembly spring and the retaining ring is as per Photo - 5 or as per Photo – 6 & 7.
- 5) The Plunger as per Photo - 6 & 7 is interchangeable and can be fitted in the existing Guide Assembly (Core Tube).
- 6) Fix Guide Assembly (Core Tube) using correct tool.
- 7) Fix the solenoid and dome nut as per Point-4 of procedure A.
- 8) Eventhough it is not recommended, in case if required, the Guide Assembly (Core Tube) (Part 33) can be opened using plier or other similar tool ensuring that the same does not damage anything or component and the plier is tighten above weld joint (weld joint should be at the centre of plier jaw width).

**(C) REPLACEMENT OF MANUAL OVERRIDE (PART 8)**

- 1) Remove Grub Hex Socket Set Screw (Part 115) and pull out Manual Override (Part 8).
- 2) Replace new Manual Override applying light layer of Silicon Grease Molykot M55 and tighten the grub screw fully till the Manual Override stops traveling in and out.
- 3) Open the Grub Hex Socket Set Screw slightly (1/4 turn) and check the smooth movement of the grub screw.
-  4) Without connecting air supply to the valve, operate Manual Override. Energise and De-energise Solenoid to check for the plunger movement (normally movement should not be there) which can be checked by click sound. After operating Manual Override if plunger movement is found, reduce length of the manual override by 0.3mm from its taper end. Continue this till click sound stops.

**(D) REPLACEMENT OF O RINGS**

- 1) Remove solenoid if necessary as per Procedure "A".
- 2) Remove Deckel (Cover) (Part 2) by opening four screws.
- 3) Remove bottom plate by opening 4 Nos. CSK Allen Head screws.
- 4) Remove Ventilboden (Valve Bottom) (Part-3).
- 5) Remove Ventilfeder (Valve Spring) (Parts-16 & 68). Ensure that the location of the same are not interchanged.
- 6) Open piston assembly using special tool at Kolben (Part-4) and opening Nut (Part-12).
- 7) Pull out Ventilteller (Pressure Plate) (Part-7) and Kolben Assembly.
- 8) Pull out Hulse (Part-116) and remove all O Rings [Piston O Ring (Part-18), Seat O Ring (Part-19)].

- 9) Clean components.
- 10) Fix new O Rings applying light layer of Molykot M55 grease.
- 11) Ensure that the O Rings and other rubber parts are compatible to the media passing through the valve.
- 12) Replace MA O Ring (Part-22), Body Pilot O ring (Part-39) and Guide O ring (Part-32) following procedure "B".
- 13) Reassemble the valve.
- 14) Check operation and leakage of the valve.
- 15) Contact ROTEX in case of any difficulty.

#### **STORING,CLEANING AND MOUNTING OF ELASTOMERS : SYNTHETIC RUBBER PRODUCTS**

- Store Plunger, O Ring Set in sealed polyethylene bag, kept in cool, dry, dust free area and avoid direct contact with all light sources emitting ultra violet rays, or contact with fumes, solvents, fuels, lubricants, chemicals, acids, disinfectants.
- Follow Maintenance General Instruction & specific procedures to replace O Ring set as listed above.



Guide Opening Tool M-28  
Photo – 1



Guide Opening Tool M-22  
Photo - 2



Manual Override "ON"  
Photo – 3



Manual Override "OFF"  
Photo – 4

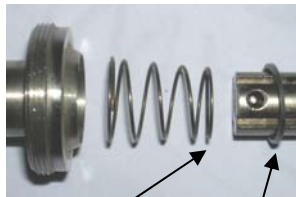

Spring Dia (Small) Flat Face this side  
Photo – 5



Plunger with fixed conical & cylindrical seal (Old Plunger)  
Photo – 6



Plunger with moving seal (New Design Plunger)  
Photo – 7



Manual Override Position interchanged for Valve Type 52400  
Photo – 8

#### **Contact :**

#### **ROTEX AUTOMATION LIMITED**

987/11, GIDC, MAKARPURA, VADODARA – 390010, INDIA

Tel. : +91 265 2638136, 2638746, 2638795 Fax : +91 265 2638130

E-mail : [rotexbrd@rotexindia.com](mailto:rotexbrd@rotexindia.com)

Website : [www.rotexindia.com](http://www.rotexindia.com)