

Plug and Socket Devices CES 125 A Series 8581



www.stahl.de



12130E00

- > Switch socket / plug 125 A
- > Large switching handle
 - with clear position indication
 - padlockable in 0- and I-position
- > Self-cleaning lamellar contacts for superior reliability
- > Minimum insertion and withdrawal forces through individually encapsulated pins, flexibly embedded
- > With an integrated auxiliary contact for control and signalling purposes
- > With motor switching capacity AC-3 acc. to IEC/EN 60947-3
- > IP66 in any application position



E3

The plug and socket devices Series 8581 are 125 A versions. An important safety criterion is the reliable load disconnect switch with the large, highly visible handle. Plugging-in and unplugging is done easily and safely in 0-position. The plugs and sockets comply with IEC/EN 60309-1/-2/-4 (CEE), IEC/EN 60079-0, IEC/EN 60079-1 and IEC/EN 60079-7. The ability to plug the Ex plug in non-Ex sockets is guaranteed, while operation of the Ex socket using a non-Ex plug is reliably prevented.

	ATEX / IECEx						Zone	NEC 505 Class I						Division	NEC 500						
	0	1	2	20	21	22		0	1	2	20	21	22		1	2	1	2	1	2	
For use in		x	x		x	x	For use in		x	x				For use in		x	x	x	x	x	x









WebCode 8581A

Plug and Socket Devices CES 125 A

Series 8581



Selection Table

Version	No. of poles	Voltage [V]	Colour code	Frequency Hz	h	Metal adapter	Order number	Weight kg
CES 125 A switch socket  01678E00	 06556E00 4 P (3 P + N)	200 ... 250	blue	50 and 60	9	--	8581/31-409	21.400
		380 ... 415	red	50 and 60	6	--	8581/31-406	21.400
		480 ... 500	black	50 and 60	7	--	8581/31-407	21.400
	 06555E00 5 P (3 P + N + PE)	200 / 346 ... 240 / 415	red	50 and 60	6	--	8581/31-506	21.400
		277 / 480 ... 288 / 500	black	50 and 60	7	--	8581/31-507	21.400
		For metal cable glands, versions with metal adapter						
	 06556E00 4 P (3 P + N)	200 ... 250	blue	50 and 60	9	2 x M50 x 1.5	8581/31-409-S011	21.400
		380 ... 415	red	50 and 60	6	2 x M50 x 1.5	8581/31-406-S011	21.400
		380 ... 415	red	50 and 60	6	2 x M63 x 1.5	8581/31-406-S010	21.400
		480 ... 500	black	50 and 60	7	2 x M50 x 1.5	8581/31-407-S011	21.400
600 ... 690		black	50 and 60	5	2 x M50 x 1.5	8581/31-405-S011	21.400	
 06555E00 5 P (3 P + N + PE)	200 / 346 ... 240 / 415	red	50 and 60	6	2 x M50 x 1.5	8581/31-506-S011	21.400	
	200 / 346 ... 240 / 415	red	50 and 60	6	2 x M63 x 1.5	8581/31-506-S010	21.400	
CES 125 A plug  02231E00	 09191E00 4 P (3 P + N)	200 ... 250	blue	50 and 60	9	--	8581/12-409	1.280
		380 ... 415	red	50 and 60	6	--	8581/12-406	1.280
		480 ... 500	black	50 and 60	7	--	8581/12-407	1.280
	 09196E00 5 P (3 P + N + PE)	200 / 346 ... 240 / 415	red	50 and 60	6	--	8581/12-506	1.380
		277 / 480 ... 288 / 500	black	50 and 60	7	--	8581/12-507	1.380

Note

- Please order the additional auxiliary contacts separately, for the order number see chapter "Accessories and Spare Parts".
- Switch sockets with Ex i auxiliary contacts available on request.
- * Earth connection outside on the enclosure 70 mm²

Explosion Protection

Global (IECEx)

Gas and dust

IECEx PTB 06.0034
Ex de IIC T6 Gb
Ex de IIC T5 Gb
with intrinsically safe auxiliary contacts:
Ex de [ib] IIC T6 Gb
Ex de [ib] IIC T5 Gb
Ex tb IIIC T60 ... T85 °C Db

Europe (ATEX)

Gas and dust

PTB 01 ATEX 1161
Ex II 2 G Ex de IIC T6 Gb
Ex II 2 G Ex de IIC T5 Gb
with intrinsically safe auxiliary contacts:
Ex II 2 G Ex de [ib] IIC T6 Gb
Ex II 2 G Ex de [ib] IIC T5 Gb
Ex II 2 D Ex tb IIIC T60 ... T85 °C Db

Certifications and certificates

Certificates

IECEx, ATEX, China (China-Ex), India (PESO), Canada (cFMus), Kazakhstan (TR), Korea (KCs), Russia (TR), Serbia (RPS), Ukraine (TR), USA (FM), Belarus (TR)

Plug and Socket Devices CES 125 A

Series 8581



Technical Data

Electrical data

Main contacts																				
Rated operational voltage	max. 690 V																			
Rated operational current	max. 125 A																			
Auxiliary contacts																				
Standard version	8080/1-1 : 1 NC contact + 1 NO contact in left installation slot NO contact ON delayed NO contact OFF leading (> 20 ms before opening of the main contacts) NC contacts synchronizing																			
Possible auxiliary contacts	max. 2 auxiliary contact blocks of type 8080/1 (slow-action contacts) 8080/1-1 : 1 NC contact / 1 NO contact NO contact ON delayed ¹⁾ NO contact OFF advanced (> 20 ms before opening of the main contacts) ¹⁾ NC contact synchronizing 8080/1-3 : 2 NC contacts ²⁾ 8080/1-4 : 2 NO contacts ²⁾ ¹⁾ only in the left installation slot, synchronising in the right installation slot ²⁾ synchronising in all installation slots																			
Rated operational voltage	250 V AC for unequal potential 125 V DC 400 V AC, for equal potential of both contacts 500 V AC, when 1 NC + 1 NO and the same potential of both contacts is used																			
Rated operational current	max. 6 A																			
Switching capacity	<table border="1"> <thead> <tr> <th>AC-12</th> <th>8080/1-3</th> <th>AC-15</th> <th>8080/1-3</th> <th>DC-12</th> </tr> <tr> <th>8080/1-1</th> <th>8080/1-4</th> <th>8080/1-1</th> <th>8080/1-4</th> <th>8080/1-</th> </tr> </thead> <tbody> <tr> <td>max. 250 V max. 500 V ^{**} max. 6 A max. 5000 VA</td> <td>max. 250 V max. 400 V ^{**} max. 6 A max. 4000 VA</td> <td>max. 250 V max. 500 V ^{**} max. 6 A max. 1000 VA</td> <td>max. 250 V max. 400 V ^{**} max. 6 A max. 1000 VA</td> <td>max. 125 V max. 6 A max. 400 W</td> </tr> </tbody> </table>					AC-12	8080/1-3	AC-15	8080/1-3	DC-12	8080/1-1	8080/1-4	8080/1-1	8080/1-4	8080/1-	max. 250 V max. 500 V ^{**} max. 6 A max. 5000 VA	max. 250 V max. 400 V ^{**} max. 6 A max. 4000 VA	max. 250 V max. 500 V ^{**} max. 6 A max. 1000 VA	max. 250 V max. 400 V ^{**} max. 6 A max. 1000 VA	max. 125 V max. 6 A max. 400 W
AC-12	8080/1-3	AC-15	8080/1-3	DC-12																
8080/1-1	8080/1-4	8080/1-1	8080/1-4	8080/1-																
max. 250 V max. 500 V ^{**} max. 6 A max. 5000 VA	max. 250 V max. 400 V ^{**} max. 6 A max. 4000 VA	max. 250 V max. 500 V ^{**} max. 6 A max. 1000 VA	max. 250 V max. 400 V ^{**} max. 6 A max. 1000 VA	max. 125 V max. 6 A max. 400 W																
Short-circuit protection	125 A gG acc. to IEC/EN 60269-2																			
Interlocked switch	3 pole switch with isolating characteristics 1 auxiliary contact (ON - delayed, OFF - advanced)																			

Ambient conditions

Version	Socket 8581/31, Plug 8581/12	
Ambient temperature	T6:	-30 ... +40 °C
	T5:	-30 ... +45 °C

Mechanical data

Service life		
electrical	20,000 operating cycles	
Mechanical	100,000 operating cycles	
Version	Socket 8581/31	
Degree of protection	IP66 acc. to IEC/EN 60529	
Material		
Enclosure material	Polyester, glas fibre reinforced, fire and saltwater resistant	
Switching handle	padlockable in position 0 and I	
Version	Plug 8581/12	
Degree of protection	IP66 acc. to IEC/EN 60529	
Enclosure material	Polyamide	

Mounting / Installation

Version	Socket 8581/31	
Connection Terminals		
Single conductor connection	35 ... 150 mm ² (AWG 2/0 ... 300 kcmil) stranded 50 ... 150 mm ² (AWG 1/0 ... 300 kcmil) finely stranded	
Multiple conductor connection	2 x 35 mm ² ... 2 x 50 mm ² (2 x AWG 2 ... 2 x AWG 1/0)	
Cable entries		
Cable gland	1 x M63 x 1.5; max. 2 x M63 x 1.5 (lateral positioning acc. to order possible)	
Stopping plug	1 x M25 x 1.5, 1 x M63 x 1.5	
Version	Plug 8581/12	
Terminals	35 mm ²	
Cable entries	30 ... 50 mm cable diameter	

E3

Plug and Socket Devices CES 125 A Series 8581



Arrangement of Earth Contact Sockets

Example:
Clock hour position,
Front view of socket

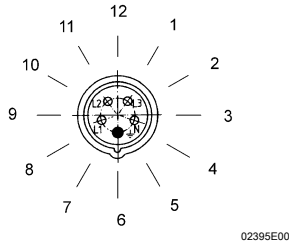



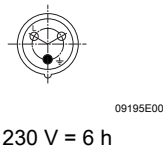

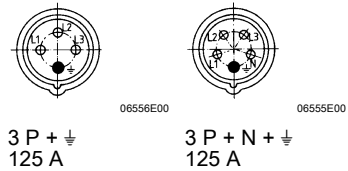

Example:
Clock hour position

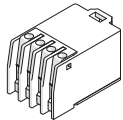

Marking of connections
Front view of socket

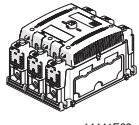

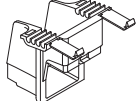
Accessories and Spare Parts

Designation	Figure	Description	Art. no.	Weight kg	
Auxiliary contact for 8581	 12446E00	2 NC contacts (8080/1-3) ²⁾	168356	0.026	
		1 NC contact + 1 NO contact (8080/1-1) ¹⁾	168351	0.026	
		2 NO contacts (8080/1-4) ²⁾	168353	0.026	
		The switching function of the auxiliary contact depends on the installation slot used. ¹⁾ Left: delayed (ON), leading (OFF); Right: synchronising ²⁾ Left and right: synchronising			
Protective cap	 05365E00	for plug 125 A 4/5 poles	153730	0.120	
Switch insert	 14441E00	8549/1-31L Load and motor switch	168776	4.720	
Plastic cable gland	 02055E00	8161/7-M25-1707 7 ... 17 mm ²	1 piece	229918	0.020
		8161/7-M63-4828 28 ... 48 mm ²	1 piece	229952	0.120
Stopping plug	 04840E00	8290/3-M25 x 1,5	1 pieces	143524	0.007
		8290/3-M63 x 1,5	1 piece	143548	0.030
Ex i cover	 12451E00	Ex i cover for auxiliary contacts for use in Ex i circuits	168855	0.008	
Auxiliary contact key	 14151E00	for removing the mounted auxiliary contact	201909	0.035	

Plug and Socket Devices CES 125 A

Series 8581



Dimensional Drawings (All Dimensions in mm) - Subject to Alterations

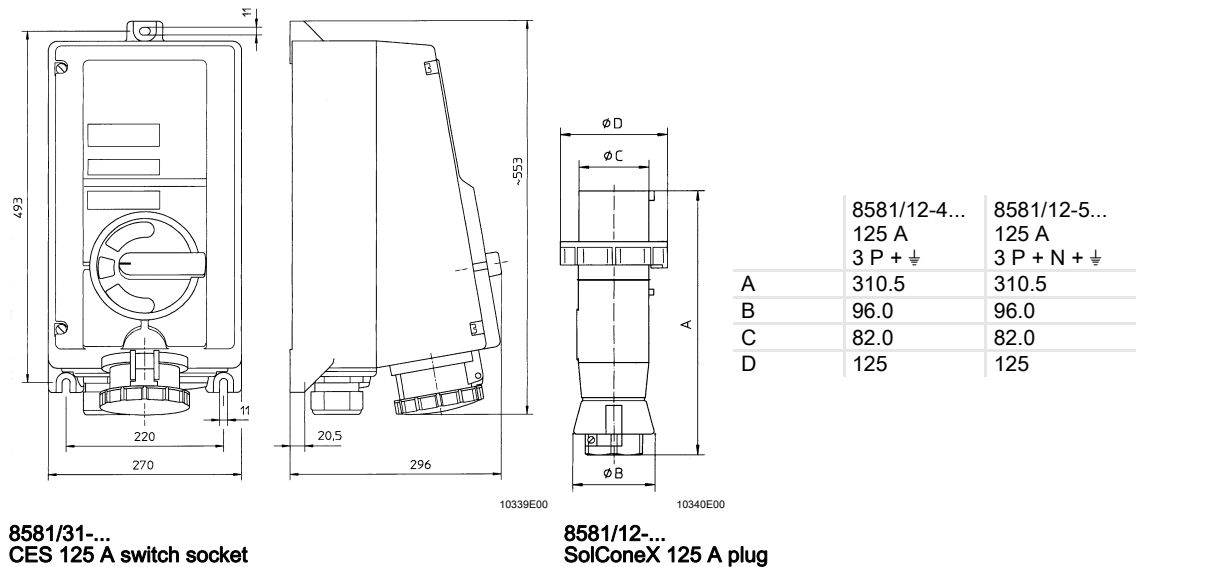

E3

We reserve the right to make alterations to the technical data, dimensions, weights, designs and products available without notice. The illustrations cannot be considered binding.